

A2167

Teste portacoltelli per esecuzione sede maniglia
Handle seat insert cutter tools

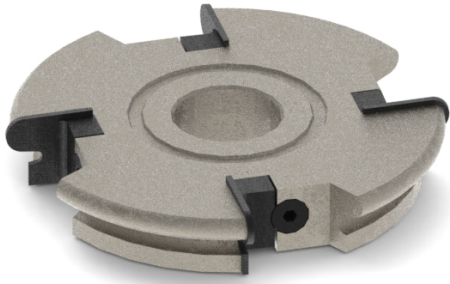

IMPIEGO / FUNCTION

toupie
spindle moulder

INFO ORDINE / ORDER INFO

Utensile equipaggiato con coltello Rif.A Drw 100194 . Altri coltelli a richiesta.

Tool equipped with knife Rif.A Drw 100194. Other knives optional.

DESCRIZIONE / DESCRIPTION

Fresa per eseguire la sede della maniglia su ante di cucine e mobili. Sostituendo i coltelli in dotazione con quelli opzionali, ordinabili a parte, è possibile ottenere sagome diverse e spessori differenti.

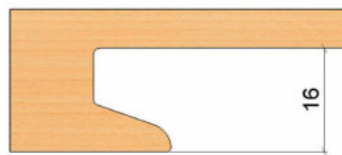
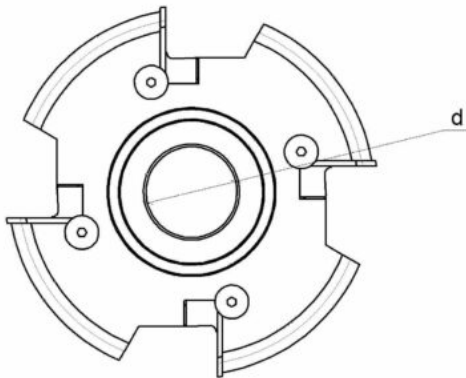
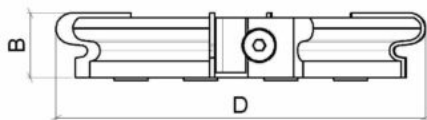

COD DIS. 100294

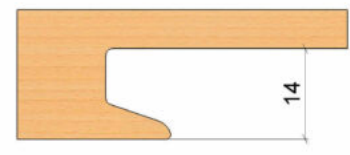

COD DIS. 100292

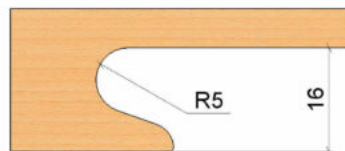

COD DIS. 100293

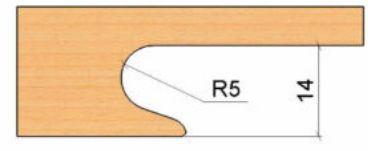



COD DIS. 100291

DATI TECNICI / TECHNICAL DATA

ART	COD	DRW	D	B	Z	d	D2	ROT
A2167	001	100194	144	25	4	30-35-40-50	120	Dx Rh

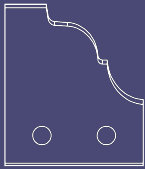
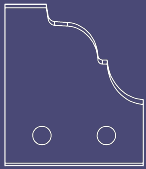
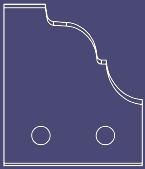
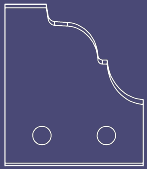
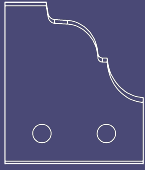
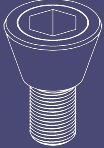
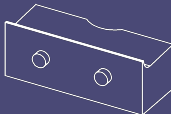
RICAMBI / SPARE PARTS

COD.		QTY		QTY		QTY		QTY
A2167.001	A0560.041.100193	4	A0560.041.100291	4	A0560.041.100292	4	A0560.041.100293	4
COD.		QTY		QTY		QTY		QTY
A2167.001	A0560.041.100294	4	A1078.015.6439	4	A1057.011.11242	4	A1077.011.14668	4