

# A2157

Teste portacoltelli per battuta inclinati assialmente

*Insert rebate cutters with shear cutting angles*

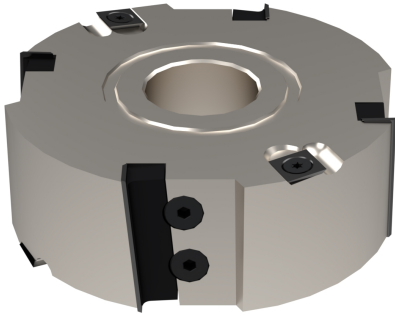

## IMPIEGO / FUNCTION

centro lavoro cnc, centro lavoro per finestre, contornatrice, scorniatrice, squadratrice, tenonatrice, toupie  
*cnc router, copy-shaping, moulder, spindle moulder, squaring machine, tenoner, window frame machine centre*

## DESCRIZIONE / DESCRIPTION

Testa portacoltelli con coltellini reversibili inclinati in HW (Hm integrale). Da B=12 a B=60 coltellini di spessore 1,5; per B=80 coltellini di 80 x 13 x 2,2.

*Insert cutters with HW (integral tungsten carbide) reversible inserts. From B=12 to B=60: inserts 1,5 mm thickness; for B=80 inserts: 80 x 13 x 2,2 mm.*

## VARIANTI / OPTIONS

Esecuzione frese Z=2: sconto 20%; esecuzione frese Z=3: sconto 10%; esecuzione frese Z=6: incremento 25%;  
*For Z=2 execution: 20%discount; for Z=3 execution: 10%discount; for Z=6 execution: 25% price increase;*

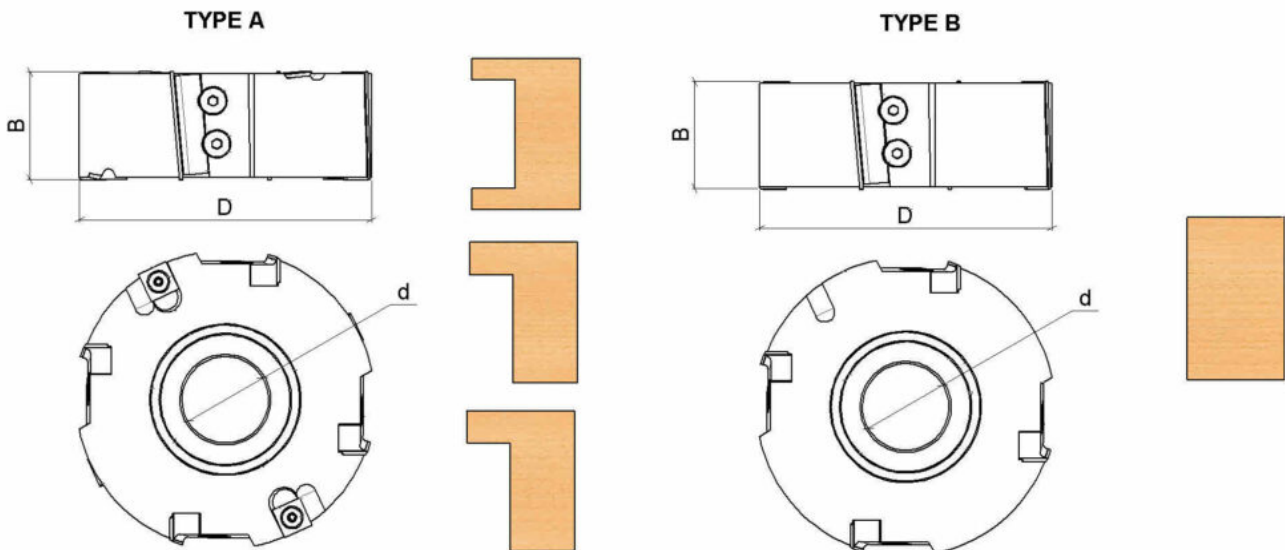



## DATI TECNICI / TECHNICAL DATA

ART	COD	DRW	D	B	Z	d	RI	ROT	RIF	GT
A2157	001	97923	140	30	4	30-35-40-50	4	Dx Rh	TYPE A	Assiale / Axial
A2157	002	97924	140	40	4	30-35-40-50	4	Dx Rh	TYPE A	Assiale / Axial
A2157	003	97925	140	50	4	30-35-40-50	4	Dx Rh	TYPE A	Assiale / Axial
A2157	004	97926	140	60	4	30-35-40-50	4	Dx Rh	TYPE A	Assiale / Axial

ART	COD	DRW	D	B	Z	d	RI	ROT	RIF	GT
A2157	005	97927	140	80	4	30-35-40-50	4	Dx Rh	TYPE A	Assiale / Axial
A2157	006	97928	160	30	4	30-35-40-50	4	Dx Rh	TYPE A	Assiale / Axial
A2157	007	97929	160	40	4	30-35-40-50	4	Dx Rh	TYPE A	Assiale / Axial
A2157	008	97930	160	50	4	30-35-40-50	4	Dx Rh	TYPE A	Assiale / Axial
A2157	009	97931	160	60	4	30-35-40-50	4	Dx Rh	TYPE A	Assiale / Axial
A2157	010	97932	160	80	4	30-35-40-50	4	Dx Rh	TYPE A	Assiale / Axial
A2157	011	97933	200	30	4	30-35-40-50	4	Dx Rh	TYPE A	Assiale / Axial
A2157	012	97934	200	40	4	30-35-40-50	4	Dx Rh	TYPE A	Assiale / Axial
A2157	013	97935	200	50	4	30-35-40-50	4	Dx Rh	TYPE A	Assiale / Axial
A2157	014	97936	200	60	4	30-35-40-50	4	Dx Rh	TYPE A	Assiale / Axial
A2157	015	97937	200	80	4	30-35-40-50	4	Dx Rh	TYPE A	Assiale / Axial
A2157	016	97938	140	30	4	30-35-40-50		Dx Rh	TYPE B	Assiale / Axial
A2157	017	97939	140	40	4	30-35-40-50		Dx Rh	TYPE B	Assiale / Axial
A2157	018	97940	140	50	4	30-35-40-50		Dx Rh	TYPE B	Assiale / Axial
A2157	019	97941	140	60	4	30-35-40-50		Dx Rh	TYPE B	Assiale / Axial
A2157	020	97942	140	80	4	30-35-40-50		Dx Rh	TYPE B	Assiale / Axial
A2157	021	97943	160	30	4	30-35-40-50		Dx Rh	TYPE B	Assiale / Axial
A2157	022	97944	160	40	4	30-35-40-50		Dx Rh	TYPE B	Assiale / Axial
A2157	023	97945	160	50	4	30-35-40-50		Dx Rh	TYPE B	Assiale / Axial
A2157	024	97946	160	60	4	30-35-40-50		Dx Rh	TYPE B	Assiale / Axial
A2157	025	97947	160	80	4	30-35-40-50		Dx Rh	TYPE B	Assiale / Axial
A2157	026	97948	200	30	4	30-35-40-50		Dx Rh	TYPE B	Assiale / Axial
A2157	027	97949	200	40	4	30-35-40-50		Dx Rh	TYPE B	Assiale / Axial
A2157	028	97950	200	50	4	30-35-40-50		Dx Rh	TYPE B	Assiale / Axial
A2157	029	97951	200	60	4	30-35-40-50		Dx Rh	TYPE B	Assiale / Axial
A2157	030	97952	200	80	4	30-35-40-50		Dx Rh	TYPE B	Assiale / Axial

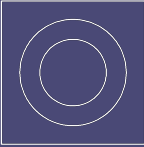
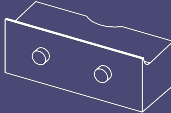
## RICAMBI / SPARE PARTS

COD.		QTY		QTY		QTY		QTY
A2157.001	A0520.008.3347	4	A0540.001.3579	4	A1057.012.5425	4	A1078.015.6439	4
A2157.002	A0520.010.3350	4	A0540.001.3579	4	A1057.014.5428	4	A1078.015.6439	8
A2157.003	A0520.012.3352	4	A0540.001.3579	4	A1057.015.5710	4	A1078.015.6439	8
A2157.004	A0520.013.3352	4	A0540.001.3579	4	A1057.016.5242	4	A1078.015.6439	8
A2157.005	A0520.014.3552	4	A0540.001.3579	4	A1057.018.6020	4	A1078.015.6439	8
A2157.006	A0520.008.3347	4	A0540.001.3579	4	A1057.012.5425	4	A1078.015.6439	4
A2157.007	A0520.010.3350	4	A0540.001.3579	4	A1057.014.5428	4	A1078.015.6439	8
A2157.008	A0520.012.3352	4	A0540.001.3579	4	A1057.015.5710	4	A1078.015.6439	8
A2157.009	A0520.013.3352	4	A0540.001.3579	4	A1057.016.5242	4	A1078.015.6439	8
A2157.010	A0520.014.3552	4	A0540.001.3579	4	A1057.018.6020	4	A1078.015.6439	8
A2157.011	A0520.008.3347	4	A0540.001.3579	4	A1057.012.5425	4	A1078.015.6439	4
A2157.012	A0520.010.3350	4	A0540.001.3579	4	A1057.014.5428	4	A1078.015.6439	8
A2157.013	A0520.012.3352	4	A0540.001.3579	4	A1057.015.5710	4	A1078.015.6439	8
A2157.014	A0520.013.3352	4	A0540.001.3579	4	A1057.016.5242	4	A1078.015.6439	8
A2157.015	A0520.014.3552	4	A0540.001.3579	4	A1057.018.6020	4	A1078.015.6439	8
A2157.016	A0520.008.3347	4	A1057.012.5425	4	A1078.015.6439	8		
A2157.017	A0520.010.3350	4	A1057.014.5428	4	A1078.015.6439	8		
A2157.018	A0520.012.3352	4	A1057.015.5710	4	A1078.015.6439	8		
A2157.019	A0520.013.3352	4	A1057.016.5242	4	A1078.015.6439	8		
A2157.020	A0520.014.3552	4	A1057.018.6020	4	A1078.015.6439	8		
A2157.021	A0520.008.3347	4	A1057.012.5425	4	A1078.015.6439	4		
A2157.022	A0520.010.3350	4	A1057.014.5428	4	A1078.015.6439	8		
A2157.023	A0520.012.3352	4	A1057.015.5710	4	A1078.015.6439	8		
A2157.024	A0520.013.3352	4	A1057.016.5242	4	A1078.015.6439	8		
A2157.025	A0520.014.3552	4	A1057.018.6020	4	A1078.015.6439	8		
A2157.026	A0520.008.3347	4	A1057.012.5425	4	A1078.015.6439	4		
A2157.027	A0520.010.3350	4	A1057.014.5428	4	A1078.015.6439	8		
A2157.028	A0520.012.3352	4	A1057.015.5710	4	A1078.015.6439	8		
A2157.029	A0520.013.3352	4	A1057.016.5242	4	A1078.015.6439	8		
A2157.030	A0520.014.3552	4	A1057.018.6020	4	A1078.015.6439	8		

COD.		QTY
A2157.001	A1081.006.34357	4
A2157.002	A1081.006.34357	4
A2157.003	A1081.006.34357	4
A2157.004	A1081.006.34357	4
A2157.005	A1081.006.34357	4
A2157.006	A1081.006.34357	4
A2157.007	A1081.006.34357	4
A2157.008	A1081.006.34357	4
A2157.009	A1081.006.34357	4
A2157.010	A1081.006.34357	4
A2157.011	A1081.006.34357	4
A2157.012	A1081.006.34357	4
A2157.013	A1081.006.34357	4
A2157.014	A1081.006.34357	4
A2157.015	A1081.006.34357	4
A2157.016		
A2157.017		
A2157.018		
A2157.019		
A2157.020		
A2157.021		
A2157.022		
A2157.023		
A2157.024		
A2157.025		
A2157.026		
A2157.027		
A2157.028		
A2157.029		
A2157.030		