



A2124

Punte per esecuzione sede maniglia
Handle seat router tools

MATERIALE LAVORATO / MATERIALS

mdf, truciolare
chipboard, mdf

IMPIEGO / FUNCTION

centro lavoro cnc
cnc router

INFO ORDINE / ORDER INFO

Utensile equipaggiato con coltello Rif.A Drw 48260. Altri coltelli a richiesta.

Tool equipped with knife Rif.A Drw 48260. Other knives optional.

DESCRIZIONE / DESCRIPTION

Punte per eseguire la sede della maniglia su ante di cucine e mobili. Sostituendo i coltelli in dotazione con quelli opzionali, ordinabili a parte, è possibile ottenere sagome diverse e spessori differenti.

Tool for making the seat of the handle on kitchen and furniture doors. By replacing the supplied knives with the optional ones, which can be ordered separately, it is possible to obtain different shapes and different thicknesses.

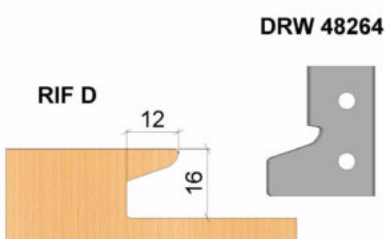
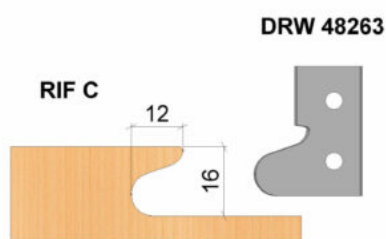
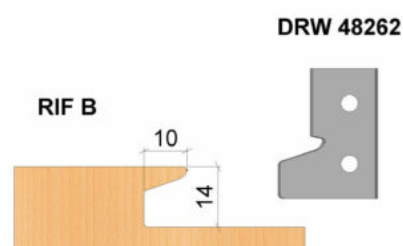
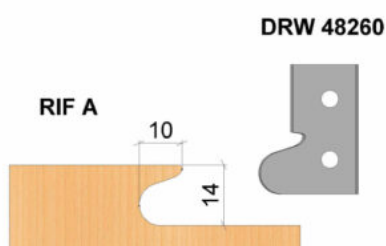
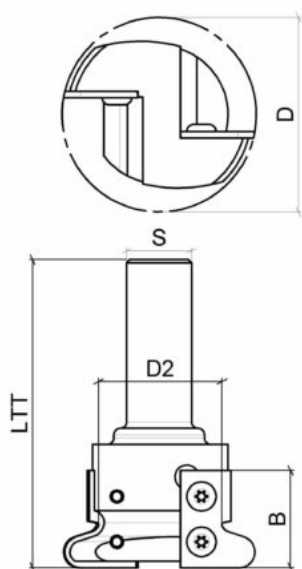

DATI TECNICI / TECHNICAL DATA

ART	COD	DRW	D	B	LTT	Z	D2	REG	ROT	S
A2124	001	48261	60	30	95	2	40	14-16	Dx Rh	20

RICAMBI / SPARE PARTS

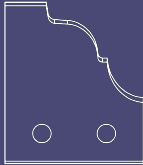
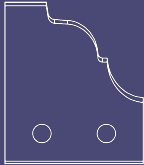
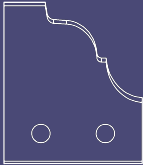
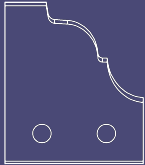
COD.		QTY		QTY		QTY		QTY
A2124.001	A0560.041.48260	2	A0560.041.48262	2	A0560.041.48263	2	A0560.041.48264	2

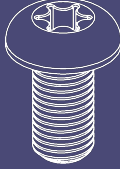
COD.		QTY
A2124.001	A1075.015.3452	4