

A0855

Guppo programmato di frese ad inserti per porte e portoni con recupero listello

Insert tools set for doors and main doors (glass fixing lath regaining)

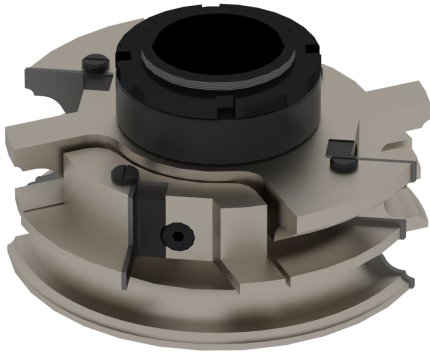

DESCRIZIONE / DESCRIPTION

Gruppi programmati a coltellini in HW(hm) con spine standard, con recupero listello per porte e portoni in legno massello con vetro o bugna riportata. canale registrabile. spigoli esterni R=3

Programmed tools with HW (hm) inserts standard pins, for solid wood doors and main-doors, with glass placed on adjustable groove. Outside bevelled angles R=3

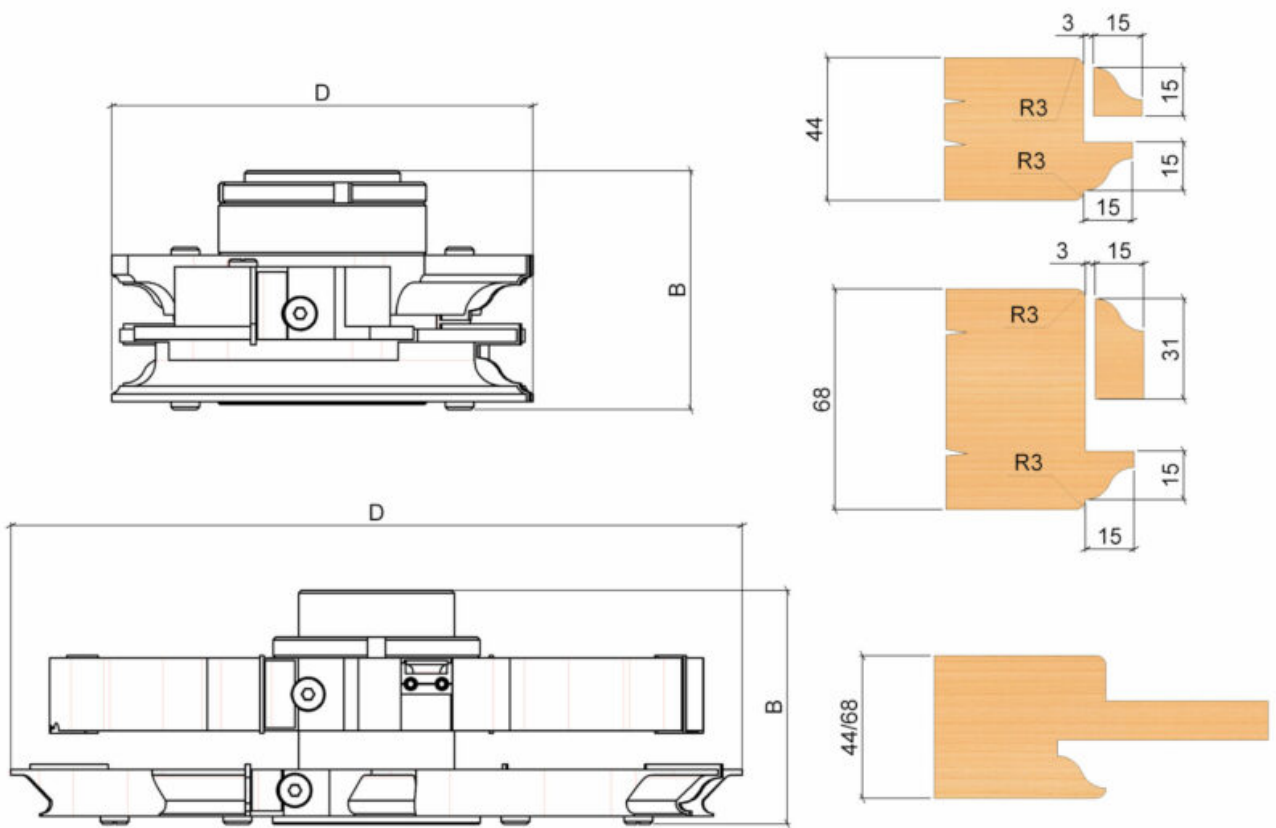

PROFILO 1
PROFILE 1



PROFILO 2
PROFILE 2



PROFILO 3
PROFILE 3

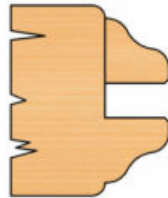

PROFILO 4
PROFILE 4

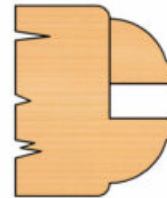

PROFILO 5
PROFILE 5

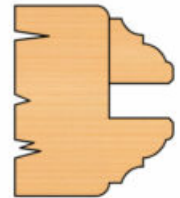

PROFILO 6
PROFILE 6

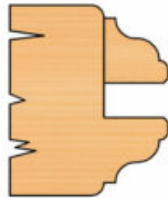

PROFILO 7
PROFILE 7

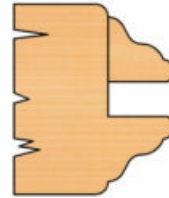

PROFILO 8
PROFILE 8

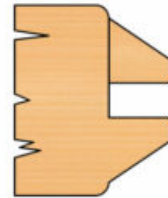

PROFILO 9
PROFILE 9

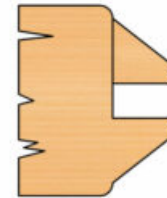

PROFILO 10
PROFILE 10



DATI TECNICI / TECHNICAL DATA

ART	COD	DRW	D	B	Z	d	D2	REG
A0855	001	5506	166	90	2	30-35-40-50	126	42-68
A0855	002	5482	320	90	4	30-35-40-50	126	42-68