

A0335

Teste rasanti per scorniciatrice
Scoring tool for moulder machine

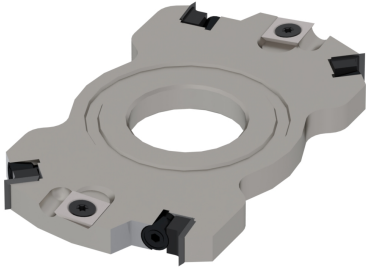

MATERIALE LAVORATO / MATERIALS

legno duro, legno tenero, mdf
hHrd wood, mdf, soft wood

IMPIEGO / FUNCTION

scorniciatrice
moulder

DESCRIZIONE / DESCRIPTION

Testa per canale guida su scorniciatrice da utilizzare nel primo albero orizzontale in combinazione con una testa pialla.

Cutter head for guide channel on moulder to be used in the first horizontal spindle in combination with a planer head.

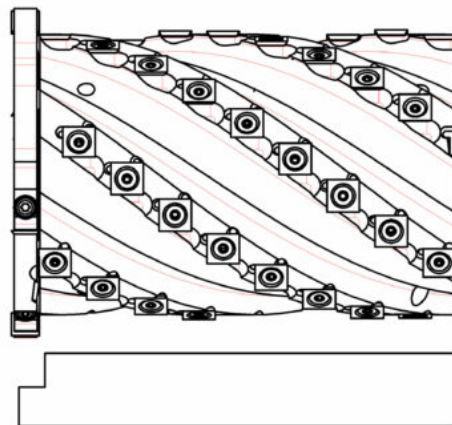
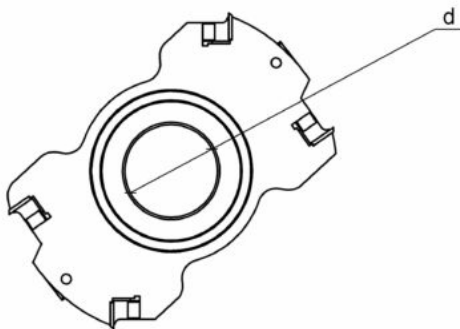
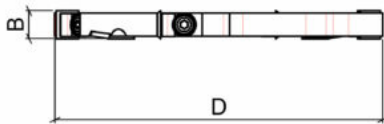

DATI TECNICI / TECHNICAL DATA

ART	COD	DRW	D	B	Z	d	RI	ROT
A0335	103	29369	145	12	4	30 35 40 50	2	Dx Rh
A0335	202	92347	160	12	4	30 35 40 50	2	Dx Rh

RICAMBI / SPARE PARTS

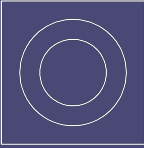
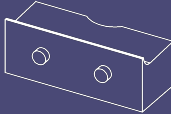
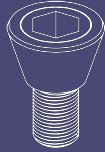
COD.		QTY		QTY		QTY		QTY
A0335.103	A0520.020.3354	4	A0540.001.3579	2	A1057.021.15806	4	A1078.012.14700	4
A0335.202	A0520.020.3354	4	A0540.001.3579	2	A1057.021.15806	4	A1078.012.14700	4

COD.		QTY
A0335.103	A1081.005.34356	2
A0335.202	A1081.005.34356	2