

# A0324

Teste portacoltelli per giunzione a 45°  
*Insert joint cutters 45°*

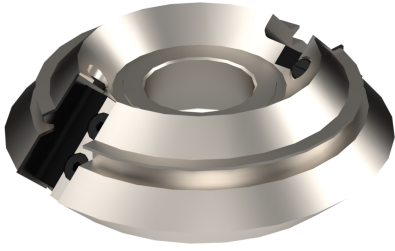

## IMPIEGO / FUNCTION

toupie  
*spindle moulder*

## DESCRIZIONE / DESCRIPTION

Teste per realizzare giunzioni complete a 45°. Il maschio e la femmina della Giunzione si ottengono lavorando il pezzo in maniera verticale o orizzontale.

*Insert cutterheads for complete 45° joint. Male and female realization is possible working the piece vertically or horizontally*

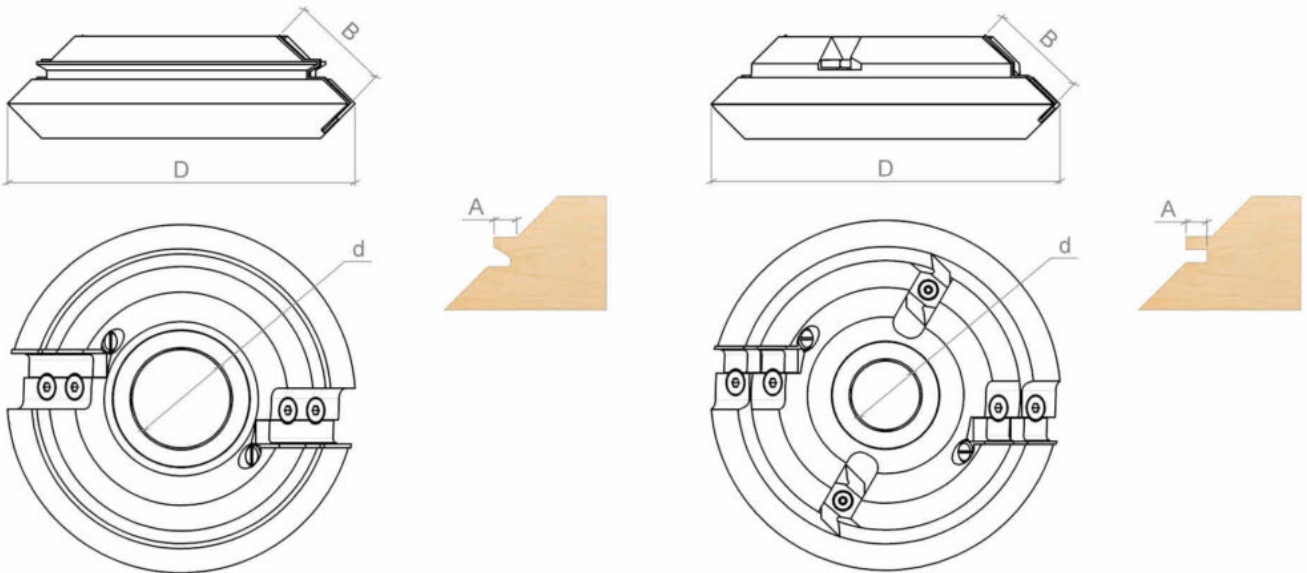



## DATI TECNICI / TECHNICAL DATA

ART	COD	DRW	D	B	Z	d	ROT	A	DC
A0324	002	21802	180	50	2	30-35-40-50	Dx Rh	6.5	2
A0324	001	11074	180	50	2	30-35-40-50	Dx Rh	7	

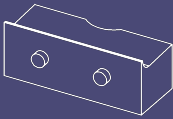
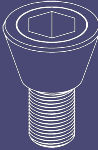
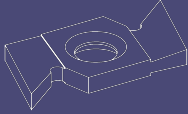
## RICAMBI / SPARE PARTS

COD.		QTY		QTY		QTY		QTY
A0324.002	A0550.026.21801	2	A1057.010.5261	4	A1078.015.6439	4	A0546.002.3581	2
A0324.001	A0560.076.11073	2			A1057.015.5710	2	A1078.015.6439	4

COD.		QTY		QTY
A0324.002	A1081.006.34357	2	A1077.012.2807	2
A0324.001			A1077.012.2807	2